

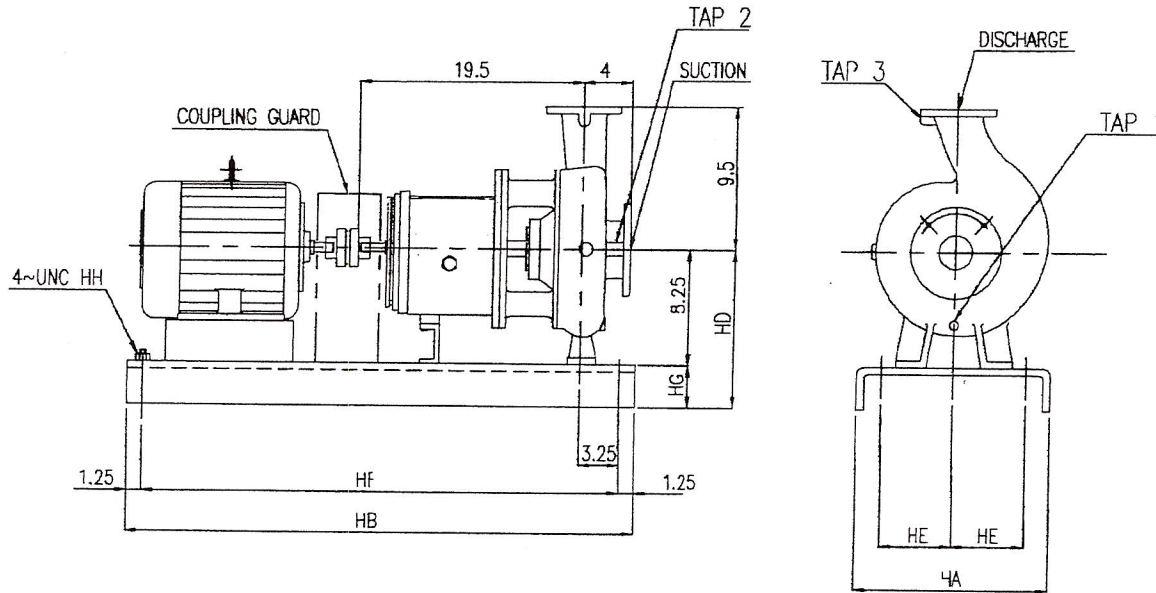

DAP PUMP OUTLINE DWG.

CUSTOMER		JOB. NO	
PO. NO		PROJECT	
ITEM NO		SERVICE	
PUMP SIZE		DAP G-2 3 x 2 - 8	
FLANGE TYPE		<input type="checkbox"/> FF <input type="checkbox"/> RF <input type="checkbox"/> #150 <input type="checkbox"/> #300	SUCTION 3 DISCHARGE 2
TAP 1	TAP 2	TAP 3	API-PLAN
POWER		BASE NO	TOTAL WEIGHT Lbs



BASE NO.	MOTOR FRAME	HA	HB	HE	HF	HD	HG	HH	REMARK
245	143T/145T	15	45	4.5	42.5	12	3.75	3/4	
	182T/184T								
252	213T/215T	18	52	6	49.5	12.25	4	3/4	
	254T/256T								
258	254T/256T	21	58	7.5	55.5	12.25	4	1	
	284T/286T								
264	324T/326T	21	64	7.5	61.5	13	4.75	1	
	364T/365T					13.75			
268	364T/365T	26	68	9.5	65.5	13.75	4.75	1	
	404T/405T					14.75			

*Dimensions can be changed by construction

REVISED 7/28/03